

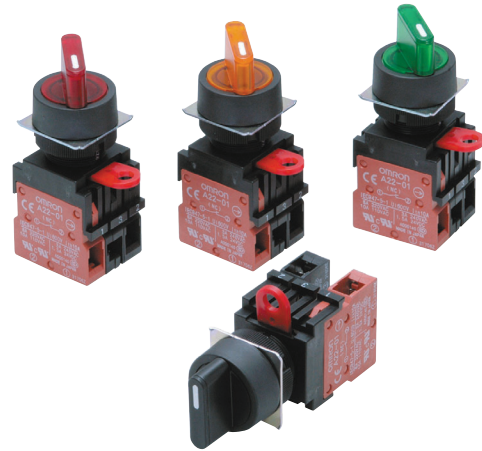

## Install in 22-dia. or 25-dia. Panel Cutout

- Lever for easily mounting and removing the Switch Unit
- Increase wiring efficiency with three-row mounting of Switch Blocks.
- Finger protection mechanism on Switch Unit provided as a standard feature.
- Use 25-dia. ring to install in 25-dia. panel cutouts.
- Mounted using either open-type (fork-type) or closed-type (round-type) crimp terminals.
- IP65 oil resistance (non-lighted models)  
IP65 (lighted models)



 Refer to *Safety Precautions for All Pushbutton Switches* and *Safety Precautions for the A22.*

## Model Number Structure

**Model Number Legend**..... Shipped as a set which includes the Selector, Lamp (lighted models only), and Switch.  
For information on combinations, refer to *Ordering Information* on pages 2 to 4.

(1) (2) (3) (4) (5)  
**A 22 W - 2M G - 6A - 11**

**(1) Lighted/Non-lighted**

Code	Description
S	Non-lighted
W	Lighted

**(3) Illumination Color**

Code	Color
R	Red
G	Green
Y	Yellow
A	Blue
None	Black*

\* For non-lighted models only

**(4) Light Source Without Voltage Reduction Unit**

Code	Type	Operating Voltage
None Non-lighted		
6A	LED	6 VAC/VDC
12A		12 VAC/VDC
24A		24 VAC/VDC
5	Incandescent lamp	5 VAC/VDC
12		12 VAC/VDC
24		24 VAC/VDC

**With Voltage Reduction Unit**

Code	Type	Operating Voltage
T1	LED	100 VAC
T2		200 VAC

• LED incorporates the 24-VAC/VDC models.

**(5) Contacts**

Code	Description
10	SPST-NO *
01	SPST-NC *
11	SPST-NO + SPST-NC
20	SPST-NO + SPST-NO
02	SPST-NC + SPST-NC

\* For models with 2 notches  
Note: The contacts are rated for standard loads. For microloads, refer to Accessories section for the A22.

**(2) Number of Notches/Reset Method**

Code	Number of Notches	Reset Method
2M	2 notches	Manual
2A		Automatic
3M	3 notches	Manual
3A		Automatic

## Ordering Information

**Completely Assembled** ..... Shipped as a set which includes the Selector, Lamp (lighted models only), and Switch.

### Non-lighted Knob-type Selector Switch

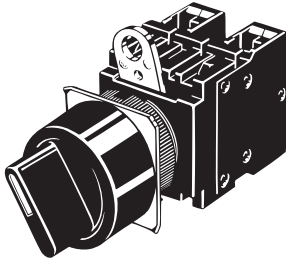
Appearance	Number of notches	Resetting method	Output	Model	Color of Selector
Knob-type Selector Switch A22S 	2 notches	Manual	SPST-NO	<b>A22S-2M-10</b>	Black
			SPST-NC	<b>A22S-2M-01</b>	
			SPST-NO + SPST-NC	<b>A22S-2M-11</b>	
			SPST-NO + SPST-NO	<b>A22S-2M-20</b>	
			SPST-NC + SPST-NC	<b>A22S-2M-02</b>	
		Automatic	SPST-NO	<b>A22S-2A-10</b>	
	SPST-NC		<b>A22S-2A-01</b>		
	SPST-NO + SPST-NC		<b>A22S-2A-11</b>		
	SPST-NO + SPST-NO		<b>A22S-2A-20</b>		
	SPST-NC + SPST-NC		<b>A22S-2A-02</b>		
	3 notches	Manual	SPST-NO + SPST-NC	<b>A22S-3M-11</b>	
			SPST-NO + SPST-NO	<b>A22S-3M-20</b>	
			SPST-NC + SPST-NC	<b>A22S-3M-02</b>	
		Automatic	SPST-NO + SPST-NC	<b>A22S-3A-11</b>	
SPST-NO + SPST-NO			<b>A22S-3A-20</b>		
SPST-NC + SPST-NC			<b>A22S-3A-02</b>		

Note: The contact ratings are for standard loads.

## Ordering Information

**Completely Assembled**..... Shipped as a set which includes the Selector, Lamp (lighted models only), and Switch.  
**Lighted Knob-type Selector Switch**

Appearance	Number of notches	Resetting method	Output	Operating voltage	Model	Illumination color	
Knob-type Selector Switch A22W LED lighting (without Voltage Reduction Unit)	2 notches	Manual	SPST-NO	6 VAC/VDC	A22W-2M□-6A-10	R (red) Y (yellow) G (green) A (blue)	
				12 VAC/VDC	A22W-2M□-12A-10		
				24 VAC/VDC	A22W-2M□-24A-10		
			SPST-NC	6 VAC/VDC	A22W-2M□-6A-01		
				12 VAC/VDC	A22W-2M□-12A-01		
				24 VAC/VDC	A22W-2M□-24A-01		
			SPST-NO + SPST-NC	6 VAC/VDC	A22W-2M□-6A-11		
				12 VAC/VDC	A22W-2M□-12A-11		
				24 VAC/VDC	A22W-2M□-24A-11		
		SPST-NO + SPST-NO	6 VAC/VDC	A22W-2M□-6A-20			
			12 VAC/VDC	A22W-2M□-12A-20			
			24 VAC/VDC	A22W-2M□-24A-20			
		SPST-NC + SPST-NC	6 VAC/VDC	A22W-2M□-6A-02			
			12 VAC/VDC	A22W-2M□-12A-02			
			24 VAC/VDC	A22W-2M□-24A-02			
		3 notches	Automatic	SPST-NO	6 VAC/VDC		A22W-2A□-6A-10
					12 VAC/VDC		A22W-2A□-12A-10
					24 VAC/VDC		A22W-2A□-24A-10
	SPST-NC			6 VAC/VDC	A22W-2A□-6A-01		
				12 VAC/VDC	A22W-2A□-12A-01		
				24 VAC/VDC	A22W-2A□-24A-01		
	SPST-NO + SPST-NC			6 VAC/VDC	A22W-2A□-6A-11		
				12 VAC/VDC	A22W-2A□-12A-11		
				24 VAC/VDC	A22W-2A□-24A-11		
	SPST-NO + SPST-NO		6 VAC/VDC	A22W-2A□-6A-20			
			12 VAC/VDC	A22W-2A□-12A-20			
			24 VAC/VDC	A22W-2A□-24A-20			
	SPST-NC + SPST-NC		6 VAC/VDC	A22W-2A□-6A-02			
			12 VAC/VDC	A22W-2A□-12A-02			
			24 VAC/VDC	A22W-2A□-24A-02			
	Manual		SPST-NO + SPST-NC	6 VAC/VDC	A22W-3M□-6A-11		
				12 VAC/VDC	A22W-3M□-12A-11		
				24 VAC/VDC	A22W-3M□-24A-11		
		6 VAC/VDC		A22W-3M□-6A-20			
		12 VAC/VDC		A22W-3M□-12A-20			
		24 VAC/VDC		A22W-3M□-24A-20			
SPST-NC + SPST-NC		6 VAC/VDC	A22W-3M□-6A-02				
		12 VAC/VDC	A22W-3M□-12A-02				
		24 VAC/VDC	A22W-3M□-24A-02				
		Automatic	SPST-NO + SPST-NC	6 VAC/VDC	A22W-3A□-6A-11		
				12 VAC/VDC	A22W-3A□-12A-11		
				24 VAC/VDC	A22W-3A□-24A-11		
SPST-NO + SPST-NO	6 VAC/VDC		A22W-3A□-6A-20				
	12 VAC/VDC		A22W-3A□-12A-20				
	24 VAC/VDC		A22W-3A□-24A-20				
SPST-NC + SPST-NC	6 VAC/VDC	A22W-3A□-6A-02					
	12 VAC/VDC	A22W-3A□-12A-02					
	24 VAC/VDC	A22W-3A□-24A-02					

Note: 1. When ordering, specify the symbol that indicates color of the Selector in the □ of the model number.  
 2. The contact ratings are for standard loads.

Individual models: Refer to pages 6 to 7.  
 (The Selector, Lamp, and Switch can be ordered separately.)

■ Specifications: Refer to the A22. ■ Dimensions: Refer to page 10.  
 ■ Accessories and tools: Refer to the A22.

## Ordering Information

**Completely Assembled** ..... Shipped as a set which includes the Selector, Lamp (lighted models only), and Switch.  
**Lighted Knob-type Selector Switch**

Appearance	Number of notches	Resetting method	Output	Operating voltage	Model	Selector symbol (color)
Knob-type Selector Switch A22W LED voltage-reduction lighting (with Voltage Reduction Unit)	2 notches	Manual	SPST-NO	100 VAC	A22W-2M□-T1-10	R (red) Y (yellow) G (green) A (blue)
				200 VAC	A22W-2M□-T2-10	
			SPST-NC	100 VAC	A22W-2M□-T1-01	
				200 VAC	A22W-2M□-T2-01	
			SPST-NO + SPST-NC	100 VAC	A22W-2M□-T1-11	
				200 VAC	A22W-2M□-T2-11	
		SPST-NO + SPST-NO	100 VAC	A22W-2M□-T1-20		
			200 VAC	A22W-2M□-T2-20		
		SPST-NC + SPST-NC	100 VAC	A22W-2M□-T1-02		
			200 VAC	A22W-2M□-T2-02		
		Automatic	SPST-NO	100 VAC	A22W-2A□-T1-10	
				200 VAC	A22W-2A□-T2-10	
	SPST-NC		100 VAC	A22W-2A□-T1-01		
			200 VAC	A22W-2A□-T2-01		
	SPST-NO + SPST-NC		100 VAC	A22W-2A□-T1-11		
			200 VAC	A22W-2A□-T2-11		
	SPST-NO + SPST-NO	100 VAC	A22W-2A□-T1-20			
		200 VAC	A22W-2A□-T2-20			
	SPST-NC + SPST-NC	100 VAC	A22W-2A□-T1-02			
		200 VAC	A22W-2A□-T2-02			
	3 notches	Manual	SPST-NO + SPST-NC	100 VAC	A22W-3M□-T1-11	
				200 VAC	A22W-3M□-T2-11	
			SPST-NO + SPST-NO	100 VAC	A22W-3M□-T1-20	
				200 VAC	A22W-3M□-T2-20	
SPST-NC + SPST-NC			100 VAC	A22W-3M□-T1-02		
			200 VAC	A22W-3M□-T2-02		
Automatic		SPST-NO + SPST-NC	100 VAC	A22W-3A□-T1-11		
			200 VAC	A22W-3A□-T2-11		
		SPST-NO + SPST-NO	100 VAC	A22W-3A□-T1-20		
			200 VAC	A22W-3A□-T2-20		
		SPST-NC + SPST-NC	100 VAC	A22W-3A□-T1-02		
			200 VAC	A22W-3A□-T2-02		

Note: 1. When ordering, specify the symbol that indicates color of the Selector in the □ of the model number.  
 2. The contact ratings are for standard loads.

Individual models: Refer to pages 6 to 7.  
 (The Selector, Lamp, and Switch can be ordered separately.)

■ Specifications: Refer to the A22. ■ Dimensions: Refer to page 10.  
 ■ Accessories and tools: Refer to the A22.

## Ordering Information

**Completely Assembled**..... The Selector, Lamp, or Switch can be ordered separately. Use them in combination for models that are not available as assembled Units. These can also be used as inventory for maintenance parts.

**Ordering: Specify the model from the listing starting on page 6.**

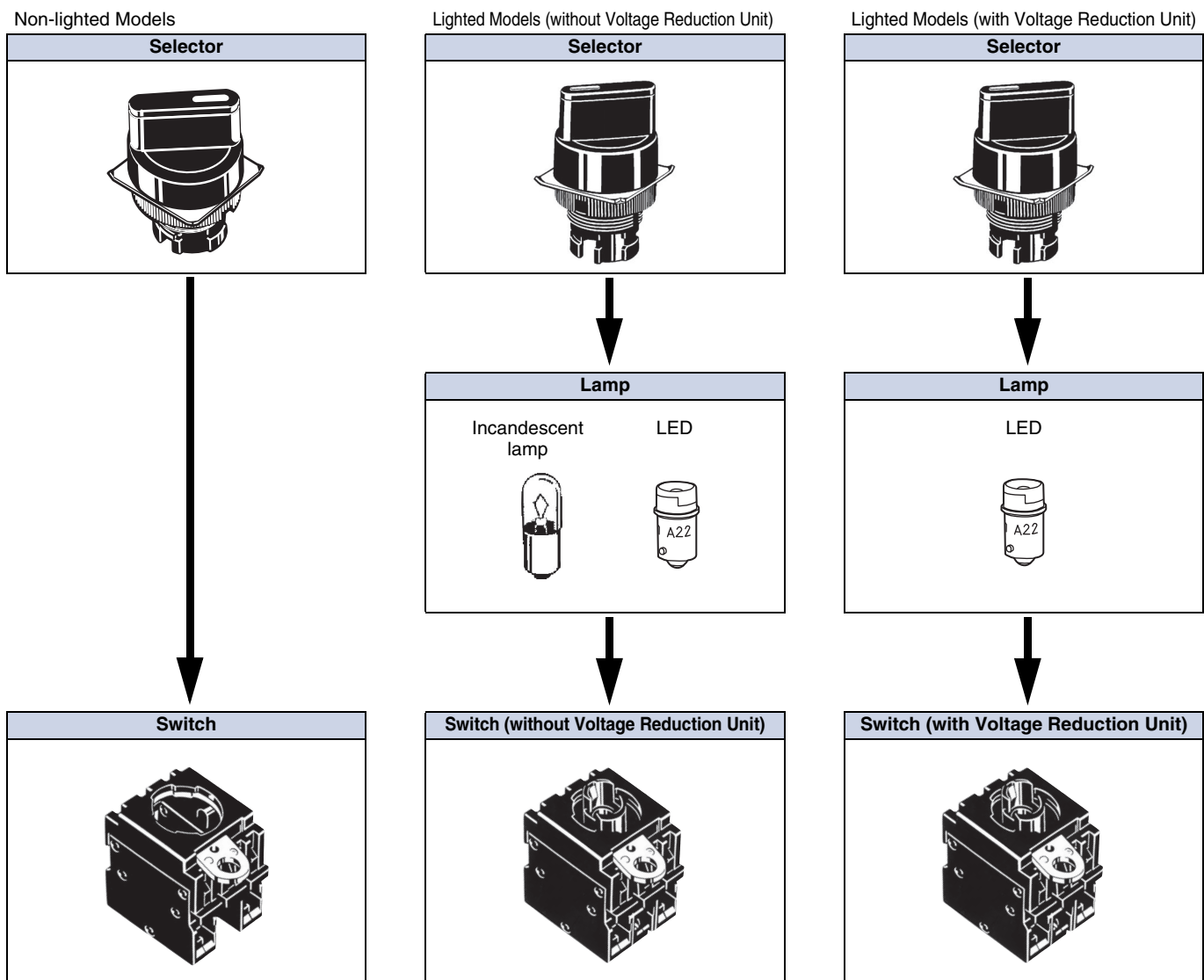

Set models: Refer to pages 2 to 4.





■ Specifications: Refer to the A22. ■ Dimensions: Refer to page 10.  
 ■ Accessories and tools: Refer to the A22.



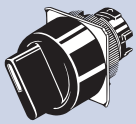

## Ordering Information

**Subassembled**..... The Selector, Lamp, or Switch can be ordered separately. Use them in combination for models that are not available as assembled Units. These can also be used as inventory for maintenance parts.





### Selectors

#### Non-lighted (Color: Only Black is Available)

Sealing		IP65 (oil-resistant)	
Appearance		Standard lever	
			
Notches	Reset method	Model	
2 notches	Manual 	A22S-2M	
	Automatic 	A22S-2A	
3 notches	Manual 	A22S-3M	
	Automatic 	A22S-3A	

Sealing		IP65 (oil-resistant)	
Appearance		Long lever	
			
Notches	Reset method	Model	
2 notches	Manual 	A22S-C2M	
	Automatic 	A22S-C2A	
3 notches	Manual 	A22S-C3M	
	Automatic 	A22S-C3A	

#### Lighted

Sealing			IP65	
Appearance			Standard lever	
				
Notches	Reset method	Selector color	Model	
2 notches	Manual 	Red	A22W-2MR	
		Green	A22W-2MG	
		Yellow	A22W-2MY	
	Automatic 	Blue	A22W-2MA	
		Red	A22W-2AR	
		Green	A22W-2AG	
3 notches	Manual 	Yellow	A22W-2AY	
		Blue	A22W-2AA	
		Red	A22W-3MR	
	Automatic 	Green	A22W-3MG	
		Yellow	A22W-3MY	
		Blue	A22W-3MA	
		Red	A22W-3AR	
		Green	A22W-3AG	
		Yellow	A22W-3AY	
		Blue	A22W-3AA	

Note: Either incandescent lamps or LED lamps can be used with the above models.

Set models: Refer to pages 2 to 4.

■ Specifications: Refer to the A22. ■ Dimensions: Refer to page 10.  
 ■ Accessories and tools: Refer to the A22.

## Ordering Information

**Subassembled** ..... The Selector, Lamp, or Switch can be ordered separately. Use them in combination for models that are not available as assembled Units. These can also be used as inventory for maintenance parts.

### Switches (Standard Load)

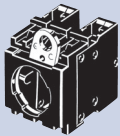
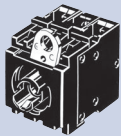
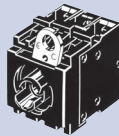
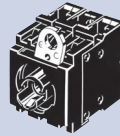
Appearance	Non-lighted	Lighted		
		Without Voltage Reduction Unit 	With Voltage Reduction Unit 110 VAC 	With Voltage Reduction Unit 220 VAC 
Contacts	Model			
SPST-NO	A22-10M	A22L-10M	A22L-10M-T1	A22L-10M-T2
SPST-NC	A22-01M	A22L-01M	A22L-01M-T1	A22L-01M-T2
SPST-NO + SPST-NC	A22-11M	A22L-11M	A22L-11M-T1	A22L-11M-T2
SPST-NO + SPST-NO	A22-20M	A22L-20M	A22L-20M-T1	A22L-20M-T2
SPST-NC + SPST-NC	A22-02M	A22L-02M	A22L-02M-T1	A22L-02M-T2

Note: For voltage-reduction lighting, use the A22-24A□. Only 24-V LED lamps can be used.

### Lamps

#### LED Lamp

Operating voltage		6 V	12 V	24 V	
Appearance	LED light	Model			
	AC and DC	Red	A22-6AR	---	---
		Green	A22-6AG	---	---
		Yellow*	A22-6AY	---	---
		Blue	A22-6AA	---	---
	Red	---	A22-12AR	A22-24AR	
	Green	---	A22-12AG	A22-24AG	
	Yellow*	---	A22-12AY	A22-24AY	
	Blue	---	A22-12AA	A22-24AA	

Note: For voltage-reduction lighting, use the A22-24A□. Only 24-V LED lamps can be used.

\* Used when the Selector color is yellow or white.

#### Incandescent Lamp

Appearance	Operating voltage	5 VAC/VDC	12 VAC/VDC	24 VAC/VDC
		A22-5	A22-12	A22-24

Set models: Refer to pages 2 to 4.

■ Specifications: Refer to the A22. ■ Dimensions: Refer to page 10.  
■ Accessories and tools: Refer to the A22.

## Nomenclature

### Model Structure

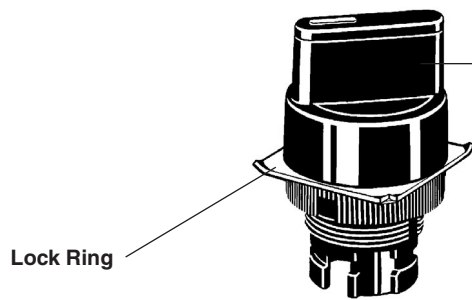

#### Selector

- **Number of Notches**  
2 notches/3 notches
- **Applicable Colors**  
Non-lighted: Black  
Lighted: Red, Green Yellow, Blue



#### Lamp

- **Light Source**  
LED lamp  
Incandescent lamp

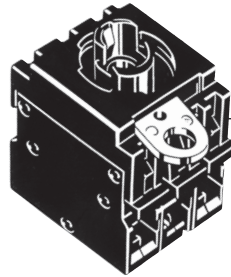

#### Switch

- **Contacts**  
SPST-NO, SPST-NC, SPST-NO + SPST-NC,  
SPST-NO + SPST-NO, SPST-NC + SPST-NC  
(Minimum applicable load: 10 mA at 5 VDC)
- **Lighting Method**  
Non-lighted  
Lighted (without Voltage Reduction Unit)  
Lighted (with Voltage Reduction Unit)

■ Specifications: Refer to the A22.  
■ Dimensions: Refer to page 10.

■ Precautions for correct use: Refer to the A22.  
■ Accessories and tools: Refer to the A22.



## Nomenclature

### Contacts

#### 2-notch Type

Knob position	SPST-NO	SPST-NC	SPST-NO + SPST-NC	SPST-NO + SPST-NO	SPST-NC + SPST-NC

#### 3-notch Type

Knob position	SPST-NO + SPST-NC	SPST-NO + SPST-NO	SPST-NC + SPST-NC

### Operation Angle

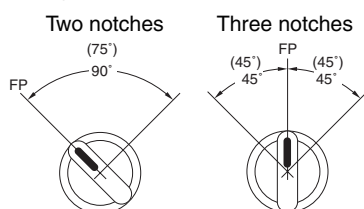

Note: 1. The angle used for automatic reset is shown in parentheses.  
 2. FP: Free Position

## Dimensions

### Knob-type Selector Switch (Lighted/Non-lighted)

Knob-type Selector Switch

A22S/A22W

A22S-C

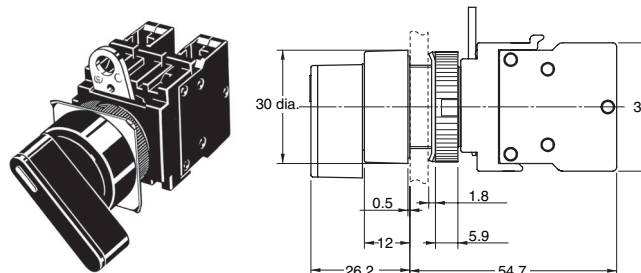
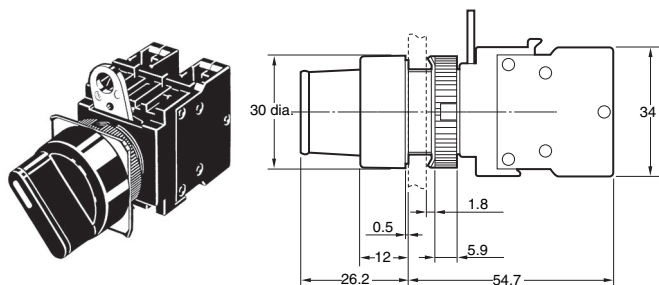

### Terminal Arrangement (Bottom View)

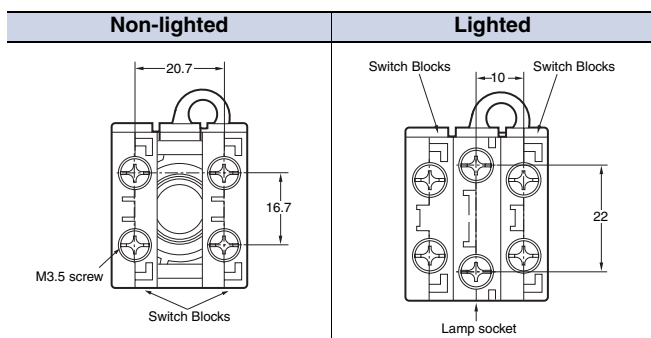

### Panel Cutouts

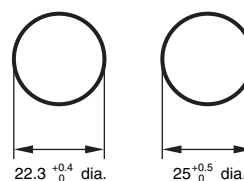

- When applying coating such as paint to the panel, the dimensions should be those after the application of coating.
- Recommended panel thickness: 1 to 5 mm.
- Use an A22Z-R25 Ring when mounting to a panel with 25-mm holes.

### Terminal Connection

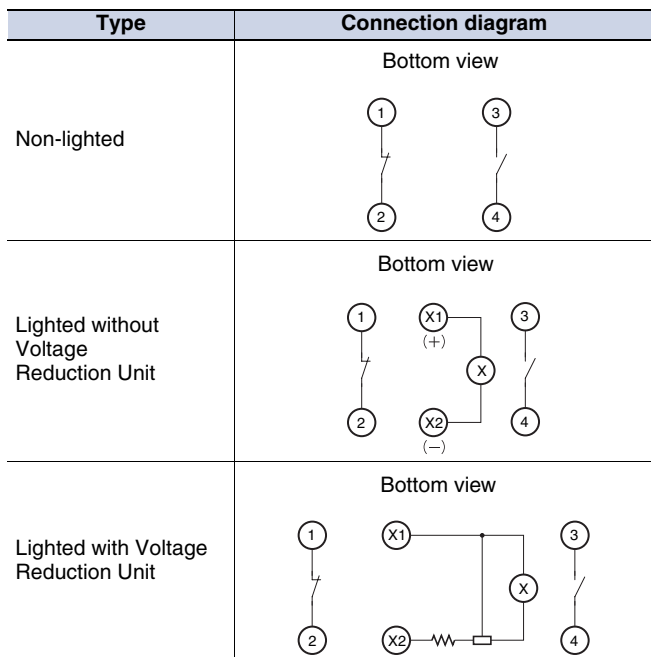

Note: The above terminal connection diagrams are examples for SPST-NO + SPST-NC.

### Accessories

Refer to the relevant information in the corresponding section for the A22.

### Safety Precautions

Refer to *Safety Precautions for All Pushbutton Switches* and *Safety Precautions for the A22*.

## Read and Understand This Catalog

Please read and understand this catalog before purchasing the products. Please consult your OMRON representative if you have any questions or comments.

## Warranty and Limitations of Liability

### WARRANTY

OMRON's exclusive warranty is that the products are free from defects in materials and workmanship for a period of one year (or other period if specified) from date of sale by OMRON.

OMRON MAKES NO WARRANTY OR REPRESENTATION, EXPRESS OR IMPLIED, REGARDING NON-INFRINGEMENT, MERCHANTABILITY, OR FITNESS FOR PARTICULAR PURPOSE OF THE PRODUCTS. ANY BUYER OR USER ACKNOWLEDGES THAT THE BUYER OR USER ALONE HAS DETERMINED THAT THE PRODUCTS WILL SUITABLY MEET THE REQUIREMENTS OF THEIR INTENDED USE. OMRON DISCLAIMS ALL OTHER WARRANTIES, EXPRESS OR IMPLIED.

### LIMITATIONS OF LIABILITY

OMRON SHALL NOT BE RESPONSIBLE FOR SPECIAL, INDIRECT, OR CONSEQUENTIAL DAMAGES, LOSS OF PROFITS OR COMMERCIAL LOSS IN ANY WAY CONNECTED WITH THE PRODUCTS, WHETHER SUCH CLAIM IS BASED ON CONTRACT, WARRANTY, NEGLIGENCE, OR STRICT LIABILITY.

In no event shall the responsibility of OMRON for any act exceed the individual price of the product on which liability is asserted.

IN NO EVENT SHALL OMRON BE RESPONSIBLE FOR WARRANTY, REPAIR, OR OTHER CLAIMS REGARDING THE PRODUCTS UNLESS OMRON'S ANALYSIS CONFIRMS THAT THE PRODUCTS WERE PROPERLY HANDLED, STORED, INSTALLED, AND MAINTAINED AND NOT SUBJECT TO CONTAMINATION, ABUSE, MISUSE, OR INAPPROPRIATE MODIFICATION OR REPAIR.

## Application Considerations

### SUITABILITY FOR USE

OMRON shall not be responsible for conformity with any standards, codes, or regulations that apply to the combination of products in the customer's application or use of the products.

At the customer's request, OMRON will provide applicable third party certification documents identifying ratings and limitations of use that apply to the products. This information by itself is not sufficient for a complete determination of the suitability of the products in combination with the end product, machine, system, or other application or use.

The following are some examples of applications for which particular attention must be given. This is not intended to be an exhaustive list of all possible uses of the products, nor is it intended to imply that the uses listed may be suitable for the products:

- Outdoor use, uses involving potential chemical contamination or electrical interference, or conditions or uses not described in this catalog.
- Nuclear energy control systems, combustion systems, railroad systems, aviation systems, medical equipment, amusement machines, vehicles, safety equipment, and installations subject to separate industry or government regulations.
- Systems, machines, and equipment that could present a risk to life or property.

Please know and observe all prohibitions of use applicable to the products.

NEVER USE THE PRODUCTS FOR AN APPLICATION INVOLVING SERIOUS RISK TO LIFE OR PROPERTY WITHOUT ENSURING THAT THE SYSTEM AS A WHOLE HAS BEEN DESIGNED TO ADDRESS THE RISKS, AND THAT THE OMRON PRODUCTS ARE PROPERLY RATED AND INSTALLED FOR THE INTENDED USE WITHIN THE OVERALL EQUIPMENT OR SYSTEM.

### PROGRAMMABLE PRODUCTS

OMRON shall not be responsible for the user's programming of a programmable product, or any consequence thereof.

## Disclaimers

### CHANGE IN SPECIFICATIONS

Product specifications and accessories may be changed at any time based on improvements and other reasons.

It is our practice to change model numbers when published ratings or features are changed, or when significant construction changes are made. However, some specifications of the products may be changed without any notice. When in doubt, special model numbers may be assigned to fix or establish key specifications for your application on your request. Please consult with your OMRON representative at any time to confirm actual specifications of purchased products.

### DIMENSIONS AND WEIGHTS

Dimensions and weights are nominal and are not to be used for manufacturing purposes, even when tolerances are shown.

### PERFORMANCE DATA

Performance data given in this catalog is provided as a guide for the user in determining suitability and does not constitute a warranty. It may represent the result of OMRON's test conditions, and the users must correlate it to actual application requirements. Actual performance is subject to the OMRON Warranty and Limitations of Liability.

### ERRORS AND OMISSIONS

The information in this document has been carefully checked and is believed to be accurate; however, no responsibility is assumed for clerical, typographical, or proofreading errors, or omissions.

2008.12

In the interest of product improvement, specifications are subject to change without notice.

**OMRON Corporation**  
Industrial Automation Company

<http://www.ia.omron.com/>

(c)Copyright OMRON Corporation 2008 All Right Reserved.

# Mouser Electronics

Authorized Distributor

Click to View Pricing, Inventory, Delivery & Lifecycle Information:

Omron:

[A22S-3A-11](#) [A22S-C3M-11](#) [A22S-2M-11](#) [A22S-2A-10](#)